

版次	变更内容	审核	日期

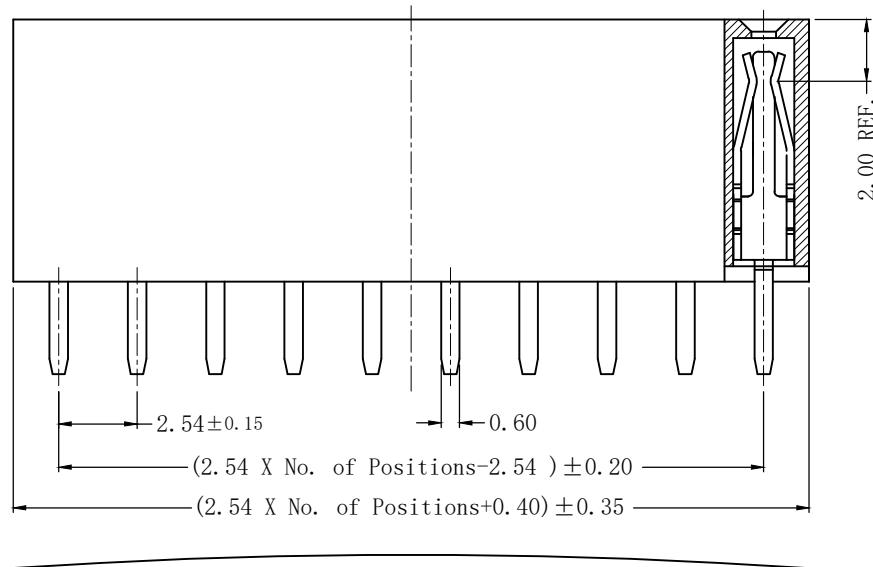
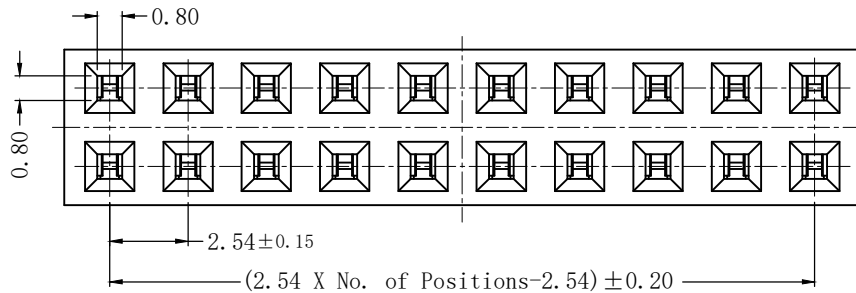

弯曲度: 2*02P ~ 2*20P 0.30 MAX.
 2*21P ~ 2*30P 0.40 MAX.
 2*31P ~ 2*40P 0.50 MAX.

技术参数: SPECIFICATIONS

额定电流 (Current Rating): 3A
 绝缘电阻 (Insulation Resistance): 1000MΩ Min.
 接触电阻 (Contact Resistance): 20mΩ Max.
 额定电压 (Dielectric Withstanding Voltage): AC 500V
 工作温度 (Operating Temperature): -40°C ~ +105°C
 最大加工温度 (Max Processing Temp): (230°C for 30~60 seconds)
 (260°C for 10 seconds)
 接触材料 (Contact Material): 磷青铜(Phosphor Bronze), THICKNESS 0.40mm
 塑胶材料 (Insulator Material): 尼龙(Nylon)-9T, UL 94V-0, 颜色: 黑色
 接触电镀 (Contact Plating): 镀金 (Gold plated)
 (电镀规格可根据客户要求来定制)
 Opitonal planting on request.

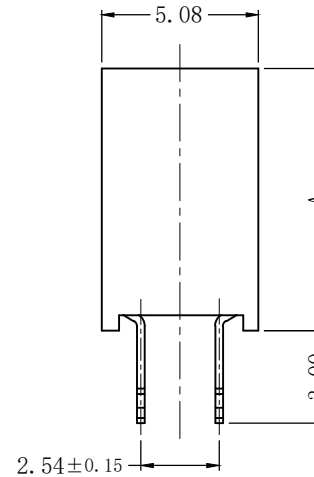

203S-3C-2*xxP G-A /B
 单排芯数 01~40P
 电镀 G: 镀金Gold Flash
 1G: 镀金1u"
 3G: 镀金3u"
 (镀金可订制)
 针长 3.0: 3.00mm
 塑高 8.5: 8.50mm
 7.1: 7.10mm

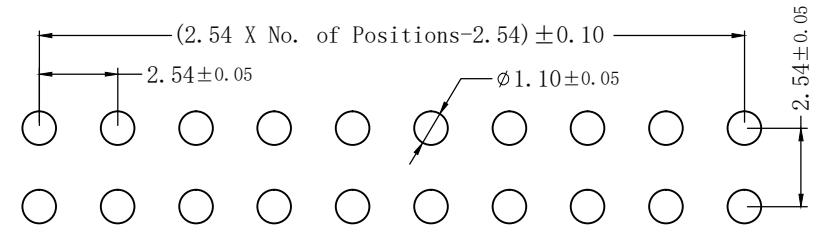

Recommended PCB Layout

公差: X ±0.35 XX ±0.25 XXX ±2° LNLB	版次:	A	上海宗进电子科技有限公司 Shanghai Zong Jin Electron Technology Co.LTD			
	比例:		型号:	203S-3C-2*xxPG-A/B	签名	日期
	单位:	mm	描述:	2.54双排直脚排母	绘图:	
	页码:	1/2	图号:		确认:	
					审核:	

版次	变更内容	审核	日期

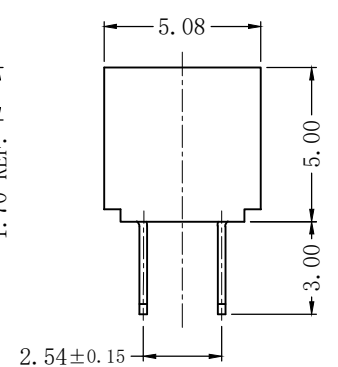
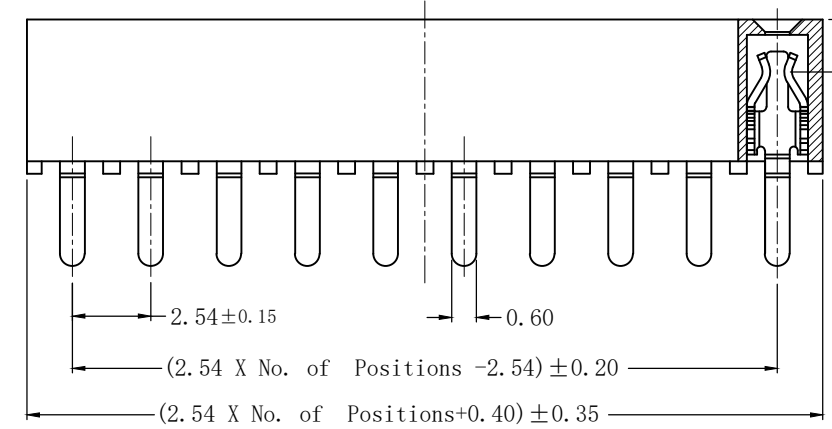
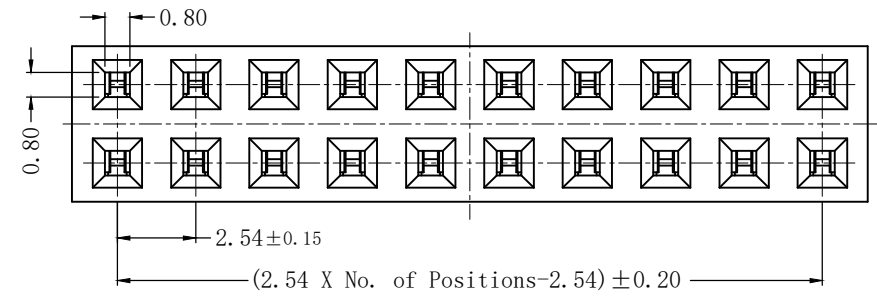

203S-3C-1*xxP G-A /B

单排芯数 01~40P

电镀

G: 镀金Gold Flash
1G: 镀金1u"
3G: 镀金3u"
(镀金可订制)

针长 3.0: 3.00mm
塑高 5.0: 5.00mm

弯曲度: 2*02P ~ 2*20P 0.30 MAX.
2*21P ~ 2*30P 0.40 MAX.
2*31P ~ 2*40P 0.50 MAX.

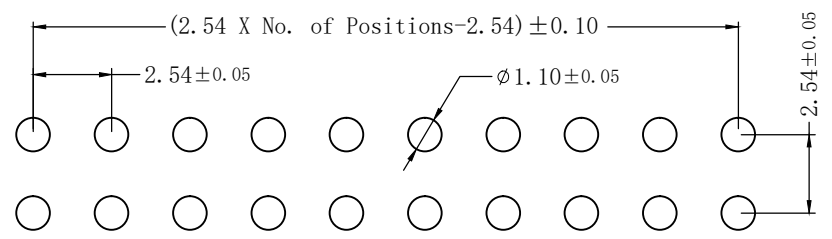

Recommended PCB Layout

技术参数: SPECIFICATIONS

额定电流 (Current Rating): 3A
 绝缘电阻 (Insulation Resistance): 1000MΩ Min.
 接触电阻 (Contact Resistance): 20mΩ Max.
 额定电压 (Dielectric Withstanding Voltage): AC 500V
 工作温度 (Operating Temperature): -40°C ~ +105°C
 最大加工温度 (Max Processing Temp): (230°C for 30~60 seconds)
 (260°C for 10 seconds)

接触材料 (Contact Material): 磷青铜 (Phosphor Bronze), THICKNESS 0.40mm
 塑胶材料 (Insulator Material): 尼龙 (Nylon)-9T, UL 94V-0, 颜色: 黑色
 接触电镀 (Contact Plating): 镀金 (Gold plated)
 (电镀规格可根据客户要求来定制)
 Opitonal planting on request.

公差:	版次:	A	上海宗进电子科技有限公司 Shanghai Zong Jin Electron Technology Co.LTD			
. X ±0.35 . XX ±0.25 . XXX ±2° LNLGB	比例:		型号:	203S-3C-2*xxPG-A/B	签名	日期
	单位:	mm	描述:	2.54双排直脚排母	绘图:	
	页码:	2/2	图号:		确认:	
					审核:	